

ELECTROLYTIC CHLORINE GENERATOR BASIC POOL MAINTENANCE REQUIREMENTS

	TEST	IDEAL RANGE	ADJUSTMENT REQUIRED
WEEKLY	Free Chlorine	1.0 - 3.0 ppm	Raise desired output % to increase, lower desired output % to decrease -OR- increase or decrease pump filtration time.
	pH	7.2 - 7.8	Too high - add muriatic acid Too low - add soda ash.
MONTHLY	Alkalinity	80 - 120 ppm	Add baking soda to increase. Add acid as required to decrease.
	Salt	2700 - 3400 ppm	Add salt as required to increase.
QUARTERLY	Stabilizer	60 - 80 ppm	Add cyanuric acid to increase.
	Calcium	200 - 400 ppm	Add calcium to increase. Drain and add water to decrease.
	Electrolytic Cell	inspect & clean	Refer to section in manual.

Head Loss Curve

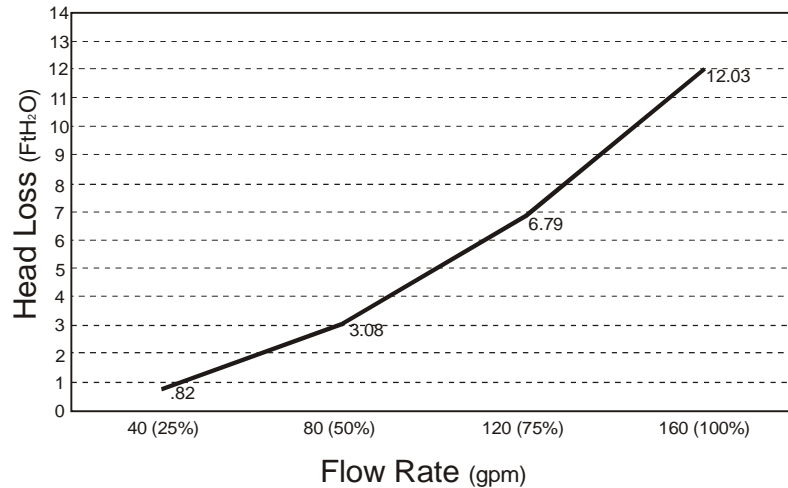

Aqua Rite®



Electronic Chlorine Generator

Operation and Installation Manual

AQR



620 Division St.
Elizabeth, NJ 07207

092009N RevP
Copyright © 2010 Hayward Inc.



www.haywardnet.com

IMPORTANT SAFETY INSTRUCTIONS

When using this electrical equipment, basic safety precautions should always be followed, including the following:

- **READ AND FOLLOW ALL INSTRUCTIONS**
- Use Copper Conductors Only
- Disconnect all AC power during installation.
- Warning - To reduce the risk of injury, do not permit children to use this product unless they are closely supervised at all times.
- A green colored terminal marked "Earth Ground" is located inside the wiring compartment. To reduce the risk of electric shock, this terminal must be connected to the grounding means provided in the electric supply service panel with a continuous copper wire equivalent in size to the circuit conductors supplying the equipment.
- One bonding lug for US models (two for Canadian models) is provided on the external surface. To reduce the risk of electric shock, connect the local common bonding grid in the area of the swimming pool, spa, or hot tub to these terminals with an insulated or bare copper conductor not smaller than 8 AWG US / 6 AWG Canada.
- All field installed metal components such as rails, ladders, drains, or other similar hardware within 3 meters of the pool, spa or hot tub shall be bonded to the equipment grounding bus with copper conductors not smaller than 8 AWG US / 6 AWG Canada.
- NOTICE TO USERS: This control product is to be used only in accordance with the directions of this label. It is an offense under the Pest Control Products Act to use a control product under unsafe conditions.
- **SAVE THESE INSTRUCTIONS**

LIMITED WARRANTY (effective 04/01/09) Hayward/Goldline warrants its Pro Logic and E-Command pool automation products as well as its Aqua Rite, Aqua Rite Pro, Aqua Plus and SwimPure chlorination products to be free of defects in materials and workmanship, under normal use and service, for a period of three (3) years. Hayward/Goldline also warrants its Aqua Trol chlorination products to be free of defects in materials and workmanship, under normal use and service for a period of one (1) year. These warranties are applicable from the initial date of installation on private residential swimming pools in the US and Canada.

Hayward/Goldline warrants all the above-identified pool automation and chlorination products installed on commercial swimming pools and on swimming pools outside of the US and Canada for a period of one (1) year. Likewise, Hayward/Goldline warrants all accessories and replacement parts for the above-identified pool automation and chlorination products for a period of one (1) year. Each of these warranties is not transferable and applies only to the original owner.

Proof of purchase is required for warranty service. If written proof of purchase is not provided, the manufacturing date code will be the sole determinant of the date of installation of the product. To obtain warranty service or repair, please contact the place of purchase or the nearest Hayward/Goldline authorized warranty service center. For more information on authorized service centers please contact the Hayward/Goldline Technical Service Support Center (61 Whitecap Road, North Kingstown RI, 02852) or visit the Goldline web site at www.goldlinecontrols.com or the Hayward website at www.haywardnet.com.

WARRANTY EXCLUSIONS:

1. Material supplied or workmanship performed by others in process of installation.
2. Damage resulting from improper installation including installation on pools larger than the product rating.
3. Problems resulting from failure to install, operate or maintain the product(s) in accordance with the recommendations contained in the owners manual(s).
4. Problems resulting from failure to maintain pool water chemistry in accordance with the recommendations in the owners manual(s).
5. Problems resulting from tampering, accident, abuse, negligence, unauthorized repairs or alternations, fire, flood, lightning, freezing, external water, degradation of natural stone used in or immediately adjacent to a pool or spa, war or acts of God.

DISCLAIMER. THE EXPRESS LIMITED WARRANTIES ABOVE CONSTITUTE THE ENTIRE WARRANTIES WITH RESPECT TO THE ABOVE-IDENTIFIED HAYWARD/GOLDLINE POOL AUTOMATION AND CHLORINATION PRODUCTS AND IS IN LIEU OF ALL OTHER WARRANTIES, EXPRESS OR IMPLIED, INCLUDING WARRANTIES OF MERCHANTABILITY OR FITNESS FOR A PARTICULAR PURPOSE. THESE WARRANTIES GIVE YOU SPECIFIC LEGAL RIGHTS, AND YOU MAY ALSO HAVE OTHER RIGHTS OF EQUIPMENT, LOST PROFITS OR REVENUE, COSTS OF RENTING REPLACEMENTS, AND OTHER ADDITIONAL EXPENSES, EVEN IF THE SELLER HAD BEEN ADVISED OF THE POSSIBILITY OF SUCH DAMAGES. SOME STATES DO NOT ALLOW THE EXCLUSION OF LIMITATION OF INCIDENTAL OR CONSEQUENTIAL DAMAGES, SO THE ABOVE LIMITATION OR EXCLUSION MAY NOT APPLY TO YOU.

NO WHOLESALE, AGENT, DEALER, CONTRACTOR OR OTHER PERSON IS AUTHORIZED TO PROVIDE, SUPPLEMENT OR MODIFY ANY WARRANTY ON BEHALF OF HAYWARD/GOLDLINE.

THESE WARRANTIES ARE VOID IF THE PRODUCT HAS BEEN ALTERED IN ANY WAY AFTER LEAVING THE FACTORY. FOR THE ABOVE-IDENTIFIED CHLORINATION PRODUCTS, THESE WARRANTIES ALSO ARE VOID IF, DURING THE WARRANTY PERIOD, YOU USE A REPLACEMENT CHLORINATOR CELL OTHER THAN AN UNMODIFIED, NEW HAYWARD/GOLDLINE CHLORINATOR CELL PURCHASED FROM HAYWARD/GOLDLINE. IF A WARRANTY BECOMES VOID, YOU STILL MAY PURCHASE SERVICE AND/OR TELEPHONE TECHNICAL SUPPORT AT THE THEN CURRENT TIME AND MATERIAL RATES.

4. "Check Salt" LED illuminated or flashing

Be sure that the correct model Turbo Cell has been selected (page 7).

Check salt level in pool/spa. If salt level is low, add salt according to chart on page 4. Before adding large quantities of salt, it is advisable to have your salt level professionally checked.

5. "High Salt" LED illuminated

Be sure that the correct model Turbo Cell has been selected (page 7).

Check salt level in pool/spa. If salt level is too high, lower salt level by draining some of the pool water out of the pool and replace with fresh water. Continue until the salt concentration is at recommended levels.

6. "Inspect Cell" LED flashing

Be sure that the correct model Turbo Cell has been selected (page 7).

Inspect and clean cell according to directions on page 8. When done, press the "diagnostic" button for 3 seconds to stop the "Inspect Cell" LED flashing.

7. "Inspect Cell" LED illuminated

Be sure that the correct model Turbo Cell has been selected (page 7).

Remove and inspect the cell for scale. If the cell is scaled, follow the directions on page 8 for cell cleaning. If the pool has the proper amount of salt and the "Inspect Cell" LED is still illuminated, the cell may be worn and need replacement.

8. Possible causes of little or no free chlorine residual

- Aqua Rite® switch in OFF position.
- Desired Output % adjustment setting is too low.
- Low stabilizer (Cyanuric Acid).
- Filter pump time too short (8 hours for average size pools, more for large pools)
- Salt level too low (below 2400 ppm, Check Salt LED on).
- Salt level too high (High Salt LED on).
- Very warm pools increase chlorine demand--increase Output %, or filter run time.
- Cold water (below 50°F) causes Aqua Rite to stop generating (Generating LED flashing).
- Excessive scaling on cell.
- High level of Nitrogen in pool water.
- "Yellow Out" or similar treatment recently used. Some yellow algae treatments will use chlorine at a very high rate and deplete the residual free chlorine. Manually shock the pool if indicated in the directions on the algae treatment. It still may be a matter of days before the pool returns to "normal" and chlorine tests will show the desired 1-3ppm free chlorine reading.

9. "-Pcb-" displayed and all 4 red/yellow LEDs are illuminated.

A possible Printed Circuit Board fault has been detected. Call for service.

Table of Contents

OPERATION

General..... 1

Water Chemistry..... 2

Controls..... 6

Maintenance..... 8

INSTALLATION

Mounting..... 10

Plumbing..... 11

Wiring..... 12

TROUBLESHOOTING

Troubleshooting..... 14

WARRANTY

Warranty..... 16

OPERATION

The Aqua Rite® is an automatic chlorine generation system for pool or spa sanitation. The operation requires a low concentration of salt (sodium chloride) in the pool water. These levels are low enough that it normally will not be tasted. The Aqua Rite automatically sanitizes your pool by converting the salt into free chlorine which kills bacteria and algae in the pool. Chlorine will revert back to sodium chloride after killing bacteria. These reactions will continuously recycle virtually eliminating the need to add sanitizing chemicals to your pool. The only time you may need to add more salt to the pool is when water is replenished due to backwashing, draining, or splashing (not evaporation).

The Aqua Rite is designed to handle the purification needs of most residential swimming pools up to 40,000 gallons (150,000 liters), or the needs of most commercial pools up to 25,000 gallons (95,000 liters). Check local codes for other restrictions. The actual amount of chlorination required to properly sanitize a pool varies due to bather load, rainfall, temperature, and the pool's cleanliness.

NOTE: Hayward does not recommend using the Aqua Rite to generate bromine.

Aqua Rite chlorine generators operating with software version 1.50 or later are designed to use one of 3 different chlorinator cells that are available from your authorized Hayward dealer. These cells are not included with the Aqua Rite and must be purchased before installation. Choose the appropriate cell based on the size of your pool. The models are shown below:

T-CELL-15- for pools up to 40,000 gallons
T-CELL-9 - for pools up to 25,000 gallons
T-CELL-3 - for pools up to 15,000 gallons

Note that the installation and mounting requirements are the same for all models.

NOTE: Before installing this product as part of a saline water purification system in a pool or spa using natural stone for coping or for immediately adjacent patios/decking, a qualified stone installation specialist should be consulted regarding the appropriate type, installation, sealant (if any) and maintenance of stone used around a saline pool with electronic chlorine generator in your particular location and circumstances.

NOTE: The use of dry acid (sodium bisulfate) to adjust pool pH is discouraged especially in arid regions where pool water is subject to excessive evaporation and is not commonly diluted with fresh water. Dry acid can cause a buildup of by-products that can damage your chlorinator cell.

Polaris - Attach wires to proper screw terminals as shown below. Note that screw terminal "1" is marked on the Polaris PCB.

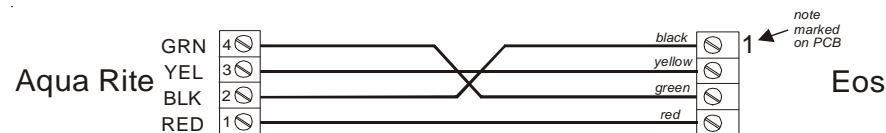

TROUBLESHOOTING

Visit www.goldlinecontrols.com for helpful information on operation, maintenance and troubleshooting your Aqua Rite® Electronic Chlorine Generator.

Diagnostic Displays

Sequential pushes of the small "diagnostic" button next to the LCD display will cause the Aqua Rite to display the following information:

1. Pool temperature (xx degrees Fahrenheit or Celsius)
2. Cell voltage (xx.x volts)
3. Cell current (x.xx amps)
4. Desired Output % ("0P" -- "100P" depending on knob position or input from remote pool automation controller)
5. Instant salinity (-xxxx ppm or -x.xx grams/Liter)
6. Product name sent to the pool automation control display ("AL-0" which signifies "Aqua Rite")
7. Software revision level (r1.xx)
8. Chlorinator cell type (t-3, t-5, t-9, t-15)

On the 9th push of the button the display will revert back to the default salt display. Also, if the button is not pushed for 30 seconds, the display will revert back to the standard salt display.

Common Problems and Solutions

1. "Power" LED not on

Check to make sure either 120VAC or 240VAC input power is connected to the proper screw terminals at the Aqua Rite control. Verify input voltage with a voltmeter. If there is input power, the fuse may have blown. The Aqua Rite is protected by a 20 amp mini ATO fuse located on the circuit board above the cell connector.

2. "Generating" LED flashing

The temperature of the pool water is too high or low to operate. You can override this by switching the main switch to SUPER CHLORINATE. The Aqua Rite will run at maximum output for the remainder of the current pump cycle or 24 hours, whichever comes first.

3. "No Flow" LED illuminated

The Aqua Rite has sensed a no flow condition and has stopped generating chlorine. Check that the flow switch is plugged into the connector on the bottom of the control unit and that the wire is not cut or damaged. Make sure you have at least 12" of straight pipe before the flow switch. If there is adequate flow and the LED is still on, check that the arrows on the flow switch (on top of hex) are pointing in the direction of flow.

Input power for use with Hayward/Goldline, Pentair and Polaris controls

Wire the Aqua Rite® **DIRECTLY** to 120/240VAC power (not through timer or relay).

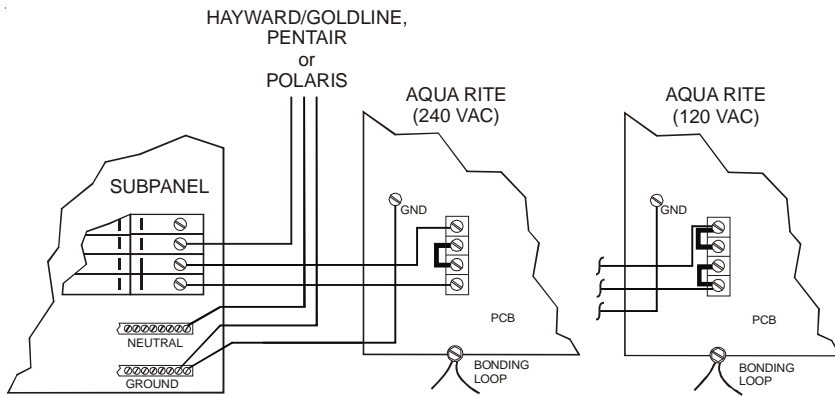

Optional Hayward/Goldline, Pentair and Polaris controls:

The Hayward/Goldline, Pentair and Polaris controls use a 4 wire connection to communicate to the Aqua Rite and can be wired up to 500' apart. Any outdoor rated 4 conductor cable can be used. Refer to each manufacturer's instructions and the wiring diagrams below for proper wiring connection to the Aqua Rite. NOTE: There must be only 1 "primary" unit. All other Aqua Rite units must be configured as "secondary".

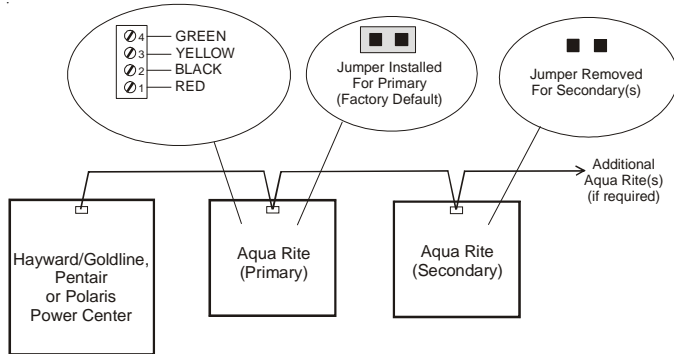

Hayward/Goldline - Attach wires to proper screw terminals as shown below.

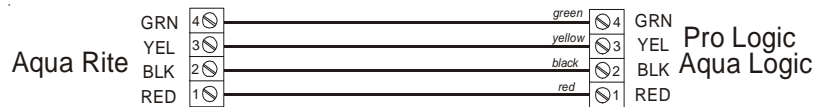

Pentair - Attach wires to opposite numbered screw terminals as shown below. **Note that the colors marked on the Pentair PCB do not match the Aqua Rite.**

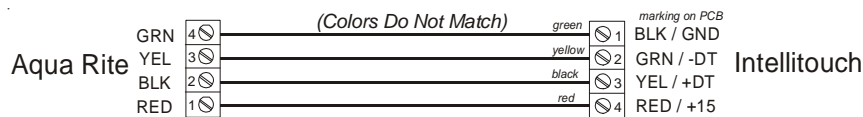

Water Chemistry

The table below summarizes the levels that are recommended by The Association of Pool and Spa Professionals (APSP). The only special requirements for the Aqua Rite are the salt level and stabilizer. It is important to maintain these levels in order to prevent corrosion or scaling and to ensure maximum enjoyment of the pool. Test your water periodically. Your Authorized Aqua Rite Dealer (AARD) or most pool stores can provide you with the chemicals and procedures to adjust the water chemistry. Be sure to tell the pool store that you are using an Aqua Rite chlorine generator.

CHEMICAL	IDEAL LEVELS
Salt	2700 to 3400 ppm
Free Chlorine	1.0 to 3.0 ppm
pH	7.2 to 7.8
Cyanuric Acid (Stabilizer)	60 to 80 ppm (80 ppm best)
Total Alkalinity	80 to 120 ppm
Calcium Hardness	200 to 400 ppm
Metals	0 ppm
Saturation Index	-.2 to .2 (0 best)

Saturation index

The saturation index (Si) relates to the calcium and alkalinity in the water and is an indicator of the pool water "balance". Your water is properly balanced if the Si is 0 ±.2. If the Si is below -0.2, the water is corrosive and plaster pool walls will be dissolved into the water. If the Si is above +0.2, scaling and staining will occur. Use the chart below to determine the saturation index.

$$Si = pH + Ti + Ci + Ai - 12.1$$

°C	°F	Ti	Calcium Hardness	Ci	Total Alkalinity	Ai
12	53	.3	75	1.5	75	1.9
			100	1.6	100	2.0
16	60	.4	125	1.7	125	2.1
			150	1.8	150	2.2
19	66	.5	200	1.9	200	2.3
			250	2.0	250	2.4
24	76	.6	300	2.1	300	2.5
			400	2.2	400	2.6
29	84	.7	600	2.4	600	2.8
			800	2.5	800	2.9
34	94	.8				
39	103	.9				

How to use: Measure pool pH, temperature, calcium hardness, and total alkalinity. Use the chart above to determine Ti, Ci, and Ai from your measurements. Insert values of pH, Ti, Ci and Ai into the above equation. If Si equals .2 or more, scaling and staining may occur. If Si equals -.2 or less corrosion or irritation may occur.

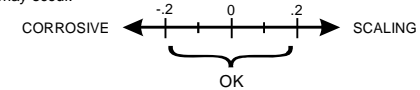

Salt Level

Use the chart on page 4 to determine how much salt in pounds or (Kgs) need to be added to reach the recommended levels. Use the equations below (measurements are in feet/gallons and meters/liters) if pool size is unknown.

	Gallons (pool size in feet)	Liters (pool size in meters)
Rectangular	Length x Width x Average Depth x 7.5	Length x Width x Average Depth x 1000
Round	Diameter x Diameter x Average Depth x 5.9	Diameter x Diameter x Average Depth x 785
Oval	Length x Width x Average Depth x 6.7	Length x Width x Average Depth x 893

The ideal salt level is between 2700-3400 ppm (parts per million) with 3200 ppm being optimal. If the level is low, determine the number of gallons in the pool and add salt according to the chart on page 4. A low salt level will reduce the efficiency of the Aqua Rite® and result in low chlorine production. A high salt level can cause the Aqua Rite® to shutdown and may begin to give a salty taste to your pool (generally, the salt will begin to be tasted at a level of about 3500-4000 ppm). The salt in your pool/spa is constantly recycled and the loss of salt throughout the swimming season should be small. This loss is due primarily to the addition of water because of splashing, backwashing, or draining (because of rain). Salt is not lost due to evaporation.

Type of Salt to Use

It is important to use only sodium chloride (NaCl) salt that is greater than 99% pure. This is common food quality or water softener salt and is usually available in 40-80 lb. bags labeled "Coarse Solar Salt". It is also acceptable to use water conditioning salt pellets, however, it will take longer for them to dissolve. Do not use rock salt, salt with yellow prussiate of soda, salt with anti-caking additives, or iodized salt.

How to Add or Remove Salt

For new plaster pools, wait 10-14 days before adding salt to allow the plaster to cure. Turn the circulating pump on and add salt directly into the pool. Brush the salt around to speed up the dissolving process--do not allow salt to pile up on the bottom of the pool. Run the filter pump for 24 hours with the suction coming from the main drain (use pool vac if there is no main drain) to allow the salt to evenly disperse throughout the pool. The salt display may take 24 hours to respond to the change in salt concentration.

The only way to lower the salt concentration is to partially drain the pool and refill with fresh water.

Always check stabilizer (cyanuric acid), when checking salt. These levels will most likely decline together. Use the chart on page 5 to determine how much stabilizer must be added to raise the level to 80 ppm.

Wiring

Power must be shut off at the circuit breaker before performing any wiring. Be sure to follow Local and NEC electrical codes. To provide safe operation, the Aqua Rite® must be properly grounded and bonded.

Input Power For stand alone operation:

Wire the Aqua Rite to the **LOAD SIDE** of the filter pump timer. It is very important that the Aqua Rite is powered only when the pump is running.

Refer to the wiring label on the Aqua Rite as well as the diagram below to determine correct wiring connections. The Aqua Rite is shipped from the factory with the configuration jumpers in 240VAC position. If using 120VAC, move the jumpers as shown below. For Canadian models, the Aqua Rite shall be connected to a circuit protected by a class A ground fault interrupter. Be sure to connect the ground wire to the green ground screw terminal located on the bottom of the enclosure.

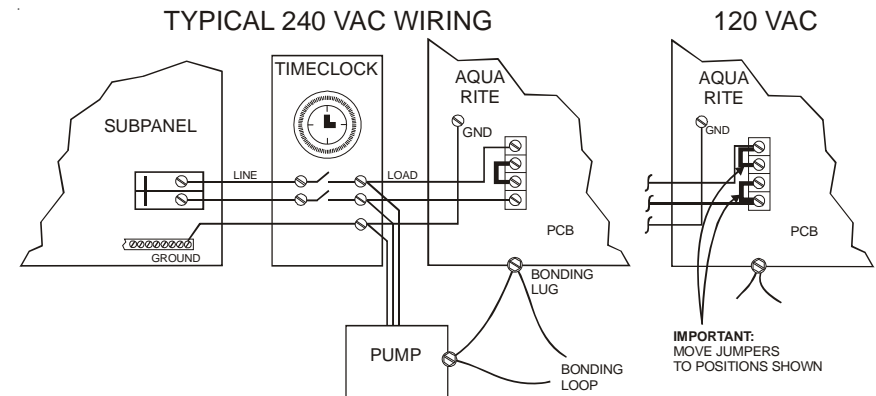

Note: Wire the pump directly to the timeclock--do not use the Aqua Rite as a junction box.

Bonding:

A lug used for bonding is attached to the bottom of the Aqua Rite enclosure (see diagram below). The Aqua Rite must be bonded with an 8 AWG copper wire (6 AWG Canada) to the pool bonding system.

Electrolytic Cell and Flow Switch:

The electrolytic cell and flow switch cables are terminated with connectors which plug into the Aqua Rite, for easy attachment and removal. The door of the Aqua Rite must be open to access the cell cable connector. The flow switch plugs into a connector (similar to a telephone jack) located outside, on the bottom of the enclosure. Refer to the diagram below for the location of these connections.

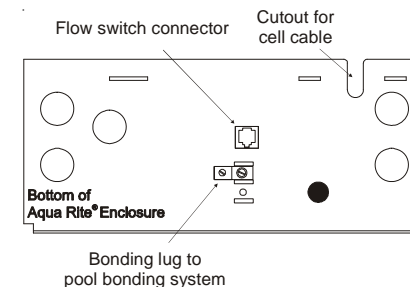

Plumbing

Ensure that the Aqua Rite® installation does not constitute a cross connection with the local potable water supply. Consult local plumbing codes.

The Aqua Rite is packaged with a flow switch and cell unions. The cell must be purchased separately. Refer to page 1 for information about available chlorinator cells.

The flow switch and cell should be plumbed in the return line to the pool/spa. The preferred installation is after (downstream) all the pool equipment (filter, heater, solar, etc.). The electrolytic cell and flow switch tee fitting are designed to be plumbed into 2" (51mm) PVC pipe. Adapters (not included) can be used for systems with 1½" (38 mm) plumbing.

For proper plumbing, refer to the overview diagram on page 9. Alternate configurations #1 shows the flow switch can also be in front of the cell. Configurations #2 and #3 allow for chlorination of both the pool and spa during spa spillover operation, but prevent overchlorination of the spa during "spa only" operation. Never use configuration #4.

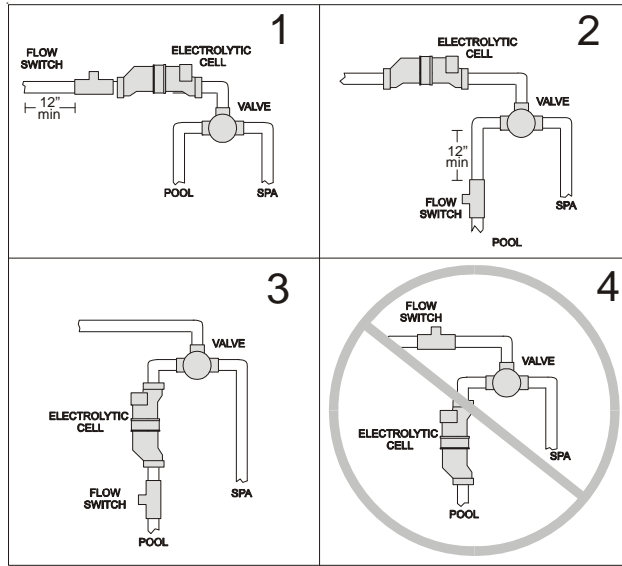

Flow Switch: IMPORTANT: There must be at least a **12" (25cm)** straight pipe run before (upstream) the flow switch. If the switch is plumbed after the cell, the cell can be counted as the 12" (25cm) of straight pipe. To ensure proper operation, verify that the arrow on the flow switch (located on top of gray hex) points in the direction of water flow.

Electrolytic Cell: Install using the unions provided. Tighten unions **BY HAND** for a watertight seal. For pool/spa combination systems with spillover, use configurations #2 or #3 above to allow chlorination of both the pool and spa during spillover but preventing overchlorination when operating the spa only.

Current salt level ppm	POUNDS and (Kg) OF SALT NEEDED FOR 3200 PPM																
	Gallons and (Liters) of Pool/Spa water																
	8,000 (30,000)	10,000 (37,500)	12,000 (45,000)	14,000 (52,500)	16,000 (60,000)	18,000 (67,500)	20,000 (75,000)	22,000 (82,500)	24,000 (90,000)	26,000 (97,500)	28,000 (105,000)	30,000 (112,500)	32,000 (120,000)	34,000 (127,500)	36,000 (135,000)	38,000 (142,500)	40,000 (150,000)
0	213 (97)	267 (121)	320 (145)	373 (170)	427 (194)	480 (218)	533 (242)	587 (267)	640 (291)	693 (315)	747 (339)	800 (364)	854 (388)	907 (412)	960 (436)	1013 (460)	1067 (484)
200	200 (91)	250 (114)	300 (136)	350 (159)	400 (182)	450 (205)	500 (227)	550 (250)	600 (273)	650 (295)	700 (318)	750 (341)	800 (363)	850 (385)	900 (408)	950 (430)	1000 (453)
400	187 (85)	233 (106)	280 (127)	327 (148)	373 (170)	420 (191)	467 (212)	513 (233)	560 (255)	607 (276)	653 (297)	700 (318)	747 (339)	793 (360)	840 (382)	887 (403)	933 (424)
600	173 (79)	217 (98)	260 (118)	303 (138)	347 (158)	390 (177)	433 (197)	477 (217)	520 (236)	563 (256)	607 (276)	650 (297)	693 (317)	737 (337)	780 (358)	823 (378)	867 (398)
800	160 (73)	200 (91)	240 (109)	280 (127)	320 (145)	360 (164)	400 (182)	440 (200)	480 (218)	520 (236)	560 (255)	600 (273)	640 (291)	680 (310)	720 (328)	760 (346)	800 (364)
1000	147 (67)	183 (83)	220 (100)	257 (117)	293 (133)	330 (150)	367 (167)	403 (183)	440 (200)	477 (217)	513 (233)	550 (250)	587 (267)	623 (283)	660 (300)	697 (317)	733 (333)
1200	133 (61)	167 (76)	200 (91)	233 (106)	267 (121)	300 (136)	333 (152)	367 (167)	400 (182)	433 (197)	467 (212)	500 (227)	533 (243)	567 (258)	600 (274)	633 (289)	667 (304)
1400	120 (55)	150 (68)	180 (82)	210 (95)	240 (109)	270 (123)	300 (136)	330 (150)	360 (164)	390 (177)	420 (191)	450 (205)	480 (218)	510 (232)	540 (246)	570 (259)	600 (283)
1600	107 (48)	133 (61)	160 (73)	187 (85)	213 (97)	240 (109)	267 (121)	293 (133)	320 (145)	347 (158)	373 (170)	400 (182)	427 (195)	453 (207)	480 (219)	507 (231)	533 (243)
1800	93 (42)	117 (53)	140 (64)	163 (74)	187 (85)	210 (95)	233 (106)	257 (117)	280 (127)	303 (138)	327 (148)	350 (159)	373 (169)	397 (180)	420 (190)	443 (201)	467 (211)
2000	80 (36)	100 (45)	120 (55)	140 (64)	160 (73)	180 (82)	200 (91)	220 (100)	240 (109)	260 (118)	280 (127)	300 (136)	320 (145)	340 (154)	360 (163)	380 (172)	400 (181)
2200	67 (30)	83 (38)	100 (45)	117 (53)	133 (61)	150 (68)	167 (76)	183 (83)	200 (91)	217 (98)	233 (106)	250 (114)	267 (122)	283 (130)	300 (137)	317 (144)	333 (152)
2400	53 (24)	67 (30)	80 (36)	93 (42)	107 (48)	120 (55)	133 (61)	147 (67)	160 (73)	173 (79)	187 (85)	200 (91)	213 (98)	227 (104)	240 (110)	253 (117)	267 (123)
2600	40 (18)	50 (23)	60 (27)	70 (32)	80 (36)	90 (41)	100 (45)	110 (50)	120 (55)	130 (59)	140 (64)	150 (68)	160 (73)	170 (77)	180 (81)	190 (86)	200 (90)
2800	27 (12)	33 (15)	40 (18)	47 (21)	53 (24)	60 (27)	67 (30)	73 (33)	80 (36)	87 (39)	93 (42)	100 (45)	107 (48)	113 (51)	120 (54)	127 (57)	133 (60)
3000	13 (6)	17 (8)	20 (9)	23 (11)	27 (12)	30 (14)	33 (15)	37 (17)	40 (18)	43 (20)	47 (21)	50 (23)	53 (24)	57 (26)	60 (27)	63 (29)	67 (30)
3200	Ideal	Ideal	Ideal	Ideal	Ideal	Ideal	Ideal	Ideal	Ideal	Ideal	Ideal	Ideal	Ideal	Ideal	Ideal	Ideal	Ideal
3400	OK	OK	OK	OK	OK	OK	OK	OK	OK	OK	OK	OK	OK	OK	OK	OK	OK
3600+	Dilute	Dilute	Dilute	Dilute	Dilute	Dilute	Dilute	Dilute	Dilute	Dilute	Dilute	Dilute	Dilute	Dilute	Dilute	Dilute	Dilute

POUNDS and (Kg) OF STABILIZER (CYANURIC ACID) NEEDED FOR 80 PPM

Current Stabilizer Level (ppm)	Gallons and (Liters) of Pool/Spa water																
	8,000 (30000)	10,000 (37500)	12,000 (45000)	14,000 (52500)	16,000 (60000)	18,000 (67500)	20,000 (75000)	22,000 (82500)	24,000 (90000)	26,000 (97500)	28,000 (105000)	30,000 (112500)	32,000 (120000)	34,000 (127500)	36,000 (135000)	38,000 (142500)	40,000 (150000)
0 ppm	5.3 (3.6)	6.7 (4.3)	8.0 (3.6)	9.4 (4.3)	10.7 (4.9)	12.0 (5.4)	13.4 (6.1)	14.7 (6.7)	16.0 (7.3)	17.3 (7.9)	18.7 (8.5)	20.0 (9.1)	21.3 (9.7)	22.7 (10.3)	24.0 (10.9)	25.3 (11.5)	26.7 (12.0)
10 ppm	4.7 (3.2)	5.8 (3.7)	7.0 (3.2)	8.2 (3.7)	9.4 (4.3)	10.5 (4.8)	11.7 (5.3)	12.9 (5.9)	14.0 (6.4)	15.2 (6.9)	16.4 (7.4)	17.2 (8.0)	18.7 (8.5)	19.8 (9.0)	21.0 (9.5)	22.2 (10.0)	23.3 (10.5)
20 ppm	4.0 (2.7)	5.0 (3.2)	6.0 (2.7)	7.0 (3.2)	8.0 (3.6)	9.0 (3.6)	10.0 (4.5)	11.0 (4.5)	12.0 (5.4)	13.0 (5.9)	14.0 (6.4)	15.0 (6.8)	16.0 (7.2)	17.0 (7.7)	18.0 (8.1)	19.0 (8.6)	20.0 (9.0)
30 ppm	3.3 (2.3)	4.2 (2.7)	5.0 (2.3)	5.9 (2.7)	6.7 (3.0)	7.5 (3.4)	8.4 (3.8)	9.2 (4.2)	10.0 (4.5)	10.8 (4.9)	11.7 (5.2)	12.5 (5.6)	13.3 (6.0)	14.2 (6.3)	15.0 (6.7)	15.8 (7.1)	16.7 (7.5)
40 ppm	2.7 (1.8)	3.3 (2.1)	4.0 (1.8)	4.7 (2.1)	5.4 (2.4)	6.0 (2.7)	6.7 (3.0)	7.4 (3.3)	8.0 (3.6)	8.7 (3.9)	9.3 (4.2)	10.0 (4.5)	10.7 (4.8)	11.3 (5.1)	12.0 (5.4)	12.7 (5.7)	13.3 (6.0)
50 ppm	2.0 (1.4)	2.5 (1.6)	3.0 (1.4)	3.5 (1.6)	4.0 (1.8)	4.5 (2.0)	5.0 (2.3)	5.5 (2.5)	6.0 (2.7)	6.5 (2.9)	7.0 (3.2)	7.5 (3.4)	8.0 (3.6)	8.5 (3.9)	9.0 (4.1)	9.5 (4.3)	10.0 (4.5)
60 ppm	1.3 (0.9)	1.7 (1.1)	2.0 (0.9)	2.3 (1.1)	2.7 (1.4)	3.0 (1.4)	3.3 (1.5)	3.7 (1.7)	4.0 (1.8)	4.3 (2.0)	4.7 (2.1)	5.0 (2.3)	5.3 (2.4)	5.7 (2.6)	6.0 (2.7)	6.3 (2.8)	6.7 (3.0)
70 ppm	0.7 (0.45)	0.8 (0.54)	1.0 (0.45)	1.2 (0.54)	1.4 (0.64)	1.5 (0.68)	1.7 (0.77)	1.8 (0.82)	2.0 (0.91)	2.2 (1.0)	2.3 (1.1)	2.5 (1.2)	2.7 (1.2)	2.8 (1.3)	3.0 (1.3)	3.2 (1.4)	3.3 (1.5)
80 ppm	0.0	0.0	0.0	0.0	0.0	0.0	0.0	0.0	0.0	0.0	0.0	0.0	0.0	0.0	0.0	0.0	0.0

INSTALLATION

Installation must be performed in accordance with Local and NEC codes.

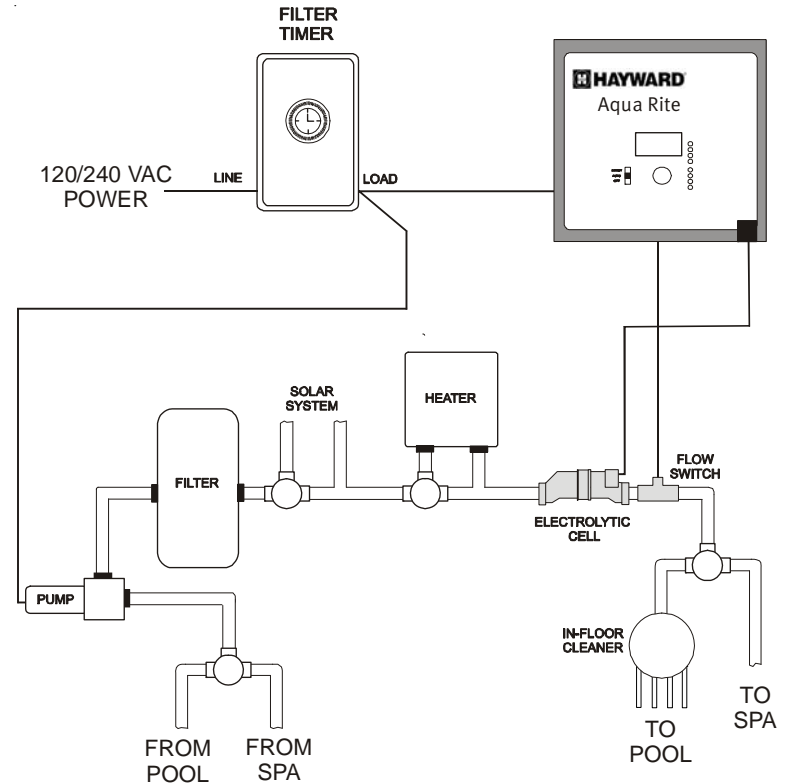

Preparing Pool/Spa Water

Refer to page 1 for recommended chemical levels. The pool's chemistry must be balanced BEFORE activating the Aqua Rite®. NOTE: If the pool does not have new water, add 1 quart (1 liter) of metal remover and 1 quart (1 liter) of non-copper based algaecide to the pool, per manufacturer's instructions. This ensures a quick, troublefree transfer to the Aqua Rite system.

Mounting the Aqua Rite Control

The Aqua Rite is contained in a raintight enclosure that is suitable for outdoor mounting. The control must be mounted a minimum of 5 ft. (2 meters) horizontal distance (or more, if local codes require) from the pool/spa.

The control is designed to mount vertically on a flat surface with the knockouts facing downward. Because the enclosure also acts as a heat sink (disperses heat from inside the box), it is important not to block the four sides of the control. Do not mount Aqua Rite inside a panel or tight enclosed area.

The Aqua Rite electrolytic cell has a self cleaning feature incorporated into the electronic control's logic. In most cases this self cleaning action will keep the cell working at optimum efficiency. In areas where water is hard (high mineral content) and in pools where the water chemistry has been allowed to get "out of balance", the cell may require periodic cleaning. The "Inspect Cell" LED will indicate if cell efficiency is decreased and servicing is necessary. If the "Inspect Cell" LED remains on after a thorough cleaning, the cell may be worn and require replacement.

Servicing and Cleaning the Aqua Rite cell

Turn off power to the Aqua Rite before removing the electrolytic cell. Once removed, look inside the cell and inspect for scale formation (light colored crusty or flaky deposits) on the plates and for any debris which has passed through the filter and caught on the plates. If no deposits are visible, reinstall. If deposits are seen, use a high pressure garden hose and try to flush the scale off. If this is not successful, use a plastic or wood tool (do not use metal as this will scratch the coating off the plates) and scrape deposits off of plates. Note that a buildup on the cell indicates that there is an unusually high calcium level in the pool (old pool water is usually the cause). If this is not corrected, you may have to periodically clean the cell. The simplest way to avoid this is to bring the pool chemistry to the recommended levels as specified.

Mild Acid Washing: Use only in severe cases where flushing and scraping will not remove the majority of deposits. To acid wash, turn off power to Aqua Rite. Remove cell from piping. In a clean plastic container, mix a 4:1 solution of water to muriatic acid (one gallon of water to one quart of muriatic acid). ALWAYS ADD ACID TO WATER - NEVER ADD WATER TO ACID. Be sure to wear rubber gloves and appropriate eye protection. The level of the solution in the container should just reach the top of the cell so that the wire harness compartment is NOT submerged. It may be helpful to coil the wiring before immersing the cell. The cell should soak for a few minutes and then rinse with a high pressure garden hose. If any deposits are still visible, repeat soaking and rinsing. Replace cell and inspect again periodically.

Winterizing

The Aqua Rite electrolytic cell and flow detection switch will be damaged by freezing water just as your pool plumbing would. In areas of the country which experience severe or extended periods of freezing temperatures, be sure to drain all water from the pump, filter, and supply and return lines before any freezing conditions occur. The electronic control is capable of withstanding any winter weather and should not be removed.

Spring Start-up

DO NOT turn the Aqua Rite on, until the pool water chemistry has been brought to the proper levels. This information can be found on page 1.

Controls Main Switch

AUTO: For normal operation, the Main Switch should be left in the AUTO position. In this position the Aqua Rite will produce chlorine according to the "Desired Output %" adjustment setting for the entire filtering/pumping cycle.

SUPER CHLORINATE: When you have an abnormally high bather load, a large amount of rain, a cloudy water condition, or any other condition which needs a large amount of purification to be introduced, put the Main Switch in the SUPER CHLORINATE position. This electronically "super chlorinates" (shocks) the water for 24 hours (filter pump must be on during this time) or until the power has been turned off, whichever comes first. At the end of the super chlorinate time, be sure to put the switch back into the AUTO position.

OFF: The OFF position prevents the Aqua Rite from energizing the electrolytic cell. In this position there is no chlorine generation. NOTE: To service any of the pool equipment or the Aqua Rite, turn the power off at the circuit breaker.

Indicator LED's

POWER When illuminated, the Aqua Rite has input power.

GENERATING This LED is on steady during normal operation. When flashing, the pool water is too hot or cold to operate.

SUPER CHLORINATE Illuminates during super-chlorination. See description above.

REMOTELY CONTROLLED When illuminated, indicates that a remote pool automation control (Hayward/Goldline Pro Logic, Pentair Intellitouch, Polaris Eos, etc.) is controlling the Aqua Rite--the main switch and "Desired Output %" adjustment are inactive. When flashing, the Pro Logic, Intellitouch or Eos is in SERVICE or TIME-OUT mode and the Main Switch and "Desired Output %" adjustment are active.

NO FLOW When illuminated, the flow switch has detected no water flowing and the Aqua Rite has stopped generating chlorine. A flashing LED indicates a 15-60 second time delay period.

CHECK SALT When flashing, the salt level is low (below 2700 ppm) and Aqua Rite is generating at low efficiency. When illuminated steady, the salt level is too low and Aqua Rite has shut down. Before adding large quantities of salt, it is advisable to have your salt level professionally checked.

HIGH SALT When illuminated, the salt level is too high and Aqua Rite has shut down.

INSPECT CELL A flashing indicator signifies that either the cell efficiency is reduced or that it is time for regularly scheduled cell inspection. In either case, inspect cell and clean if necessary. When illuminated steady, cell efficiency is greatly reduced and the Aqua Rite has stopped producing chlorine. Inspect, clean or replace if necessary.

To Set Turbo Cell Type

Before operation, the Aqua Rite must be configured for the chlorinator cell that will be used. Refer to the following information and steps below to set the Turbo cell type.

"t-3" = T-CELL-3, GLX-CELL-3-W
"t-5" = GLX-CELL-5, GLX-CELL-5-W
"t-9" = T-CELL-9, GLX-CELL-9-W
"t-15" = T-CELL-15, GLX-CELL-15-W

1. Slide the Main Switch to the "Auto" position.
2. Push the Diagnostic button repeatedly until "t-xx" appears on the display ("t-15" is the factory default). If the desired cell type is displayed skip to step 4.
3. To change to a different cell type, slide the Main Switch from "Auto" to "Super Chlorinate" and back to "Auto". Repeat this process until the desired cell type is displayed.
4. Push the Diagnostic button to exit.

Desired Output %" adjustment knob

The "Desired Output %" adjustment knob is located in the lower center of the Aqua Rite control panel. This setting is used to control the amount of chlorine the Aqua Rite generates. Raise this setting to increase chlorine level and lower it to decrease chlorine level. Note: The "Desired Output %" adjustment will not function when the Aqua Rite is being controlled by a remote pool automation control.

Salt Display

Refer to the Water Chemistry section for recommended salt levels as well as how to add/remove salt. The Salt Display shows the average salt level of the pool water. The factory default display is in English units (ppm). If Metric units (grams per liter) are preferred, follow the procedure under Temperature Display.

Temperature Display

The Temperature Display shows the current temperature of the pool water. The factory default display is in °F. Both the Temperature Display and the Salt Display can be programmed to display in Metric units. To display temperature in °C and salt level in g/l, perform the following steps:

1. Slide the Main Switch to the "Auto" position.
2. Push the Diagnostic button repeatedly until "°F" appears on the display.
3. Slide the Main Switch from "Auto" to "Super Chlorinate" and back to "Auto".
4. Push the Diagnostic button to exit.

Instant Salinity

The Instant Salinity display is the measured salt level of the pool water at that moment. If salt has recently been added, the Instant Salinity may show the change while the Salt Display (average salt level) may take some time before the changes can be seen. Under these circumstances, you may want to "update" the Salt Display to the new Instant Salinity value. This action will clear the Salt Display and substitute the Instant Salinity value. To do this, follow the steps below.

1. Slide the Main Switch to the "Auto" position.
2. Push the Diagnostic button repeatedly until "-xxxx ppm" appears on the display.
3. Slide the Main Switch from "Auto" to "Super Chlorinate" and back to "Auto".
4. Push the Diagnostic button to exit.

Operation

Assuming that the water chemical levels are in the recommended range, there are three factors that you can control which directly contribute to the amount of chlorine the Aqua Rite will generate:

1. filter time each day (hours)
2. the "Desired Output %" setting
3. the amount of salt in the pool

The filter pump timer should be set so that all of the water in the pool passes through the filter each day. For pools with high chlorine demand, the timer may have to be set longer to generate enough chlorine.

To find the optimum "Desired Output %" setting, start at approximately 50%. Test the chlorine level every few days and adjust the dial up or down accordingly. It usually takes 2-3 adjustments to find the ideal setting for your pool/spa and after that, it should only take minor, infrequent adjustments. Because the chlorine demand of the pool increases with temperature, most people find they have to adjust the dial up at the peak of the summer and down during the colder periods. The Aqua Rite automatically stops generating when the pool water temperatures drops below 50°F. This is usually not a problem because bacteria and algae stop growing at this temperature. You can override this low temperature cutoff by switching to SUPER CHLORINATE for a day.

NOTE: After the ideal "Desired Output %" setting has been found, you may need to raise the setting when the pool water temperature increases significantly, when there is higher than normal bather load or when your chlorinator cell ages. You may need to lower the setting when the pool water temperature decreases significantly or there are long periods of inactivity.

Prevent over-chlorination during cold weather: Check chlorine levels periodically. Most pools require less chlorine during cold weather and the "Desired Output %" should be lowered accordingly.

When connected to a pool automation control (Hayward/Goldline Pro Logic, Pentair Intellitouch or Polaris Eos):

The Aqua Rite is designed to operate with all pool automation controls. The Pro Logic, Intellitouch or Eos can fully control the function of the Aqua Rite chlorinator in addition to the other pool equipment. The "Remotely Controlled" LED on the Aqua Rite chlorinator will be illuminated when the automation control is activated. Adjustment of the Aqua Rite "Desired Output %" and also Superchlorination can be controlled from the pool automation display/keypad. Refer to the pool automation control instructions for more information. The Aqua Rite salt display and LED indicators operate as normal, but the main switch and "Desired Output %" dial are disabled.

Maintaining the Aqua Rite System

To maintain maximum performance, it is recommended that you open and visually inspect the cell every 3 months or after cleaning your filter. The Aqua Rite® will remind you to do this by flashing the "Inspect Cell" LED after approximately 500 hours of operation. After you inspect the cell (and clean, if necessary) press the small "diagnostic" button next to the display for 3 seconds to stop the flashing "Inspect Cell" LED and start the timer for the next 500 hours.